



Der Schlüssel zum Erfolg



Schlüssel-Rohlinge

Key blanks

Ébauches

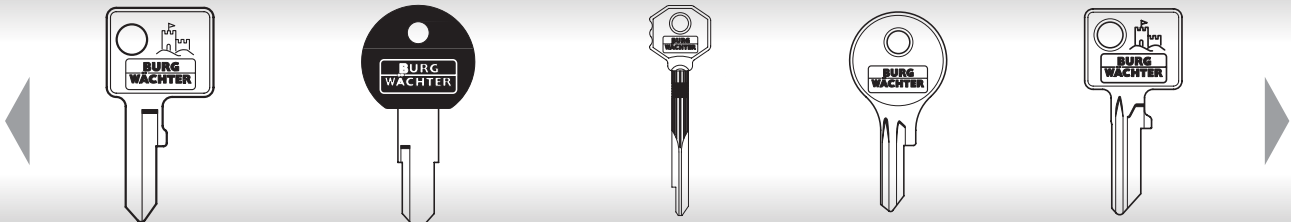

Rohlinge für Vorhangschlösser / Key blanks for padlocks / Ébauches pour cadenas



Schlüsselform

Flat keys & Shape

Forme de la clé

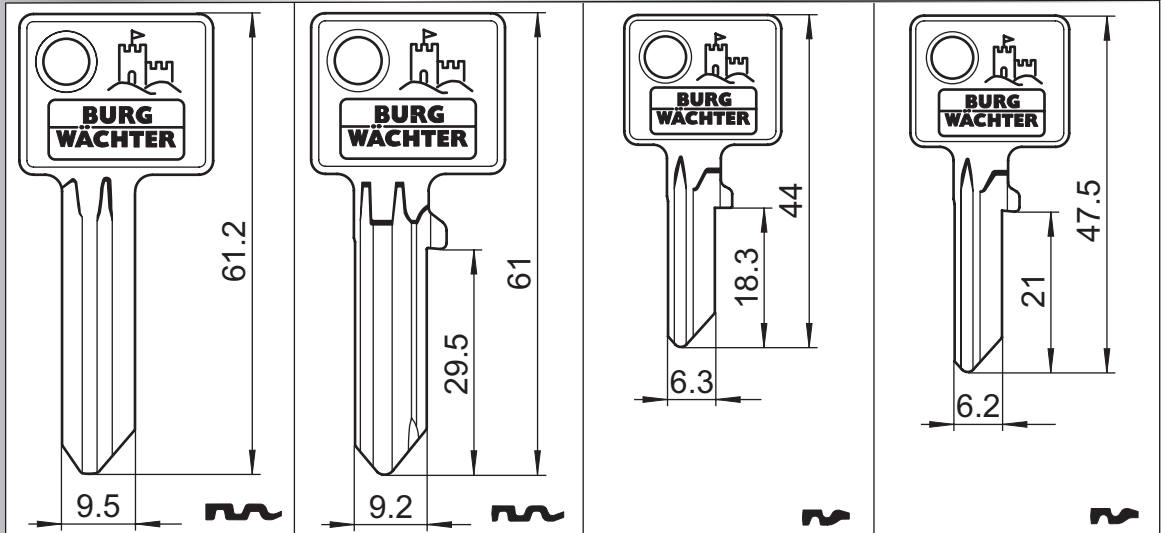

Rohling-Nr.

Item-no.
No de l'ébauche

62

60 R

64 R

65 R

EDV Nr.

4360

17700

15110

6390

Passend zu

Fits
Compatible avec

Alpha 800

D 600
GAMMA 700

116/20 - 25
217/30

116/30
217/40
Look 217 /40 Rot

VE / Unit / Cdt

20

20

50

50

Schlüsselform

Flat keys & Shape

Forme de la clé

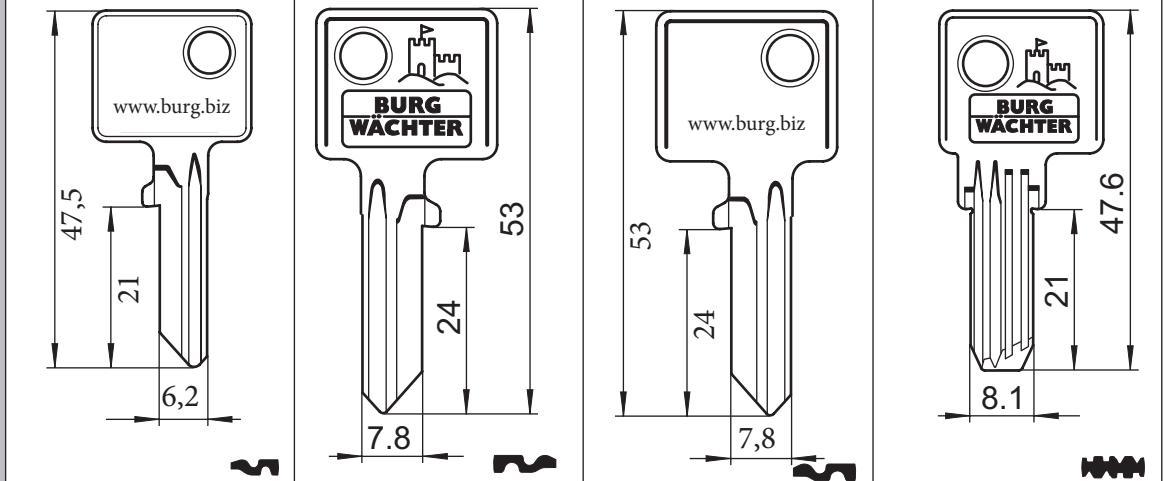

Rohling-Nr.

Item-no.
No de l'ébauche

65 L

66 R

66 L

75 W

EDV Nr.

6380

6450

6440

14710

Passend zu

Fits
Compatible avec

116/30
217/40
Look 217 /40 Rot

116/40-50-60
217/50

116/40-50-60
217/50

450/30 - 40

VE / Unit / Cdt

50

50

50

20

Rohlinge für Vorhangschlösser / Key blanks for padlocks / Ébauches pour cadenas

**BURG
WÄCHTER**

Schlüsselform

Flat keys & Shape

Forme de la clé

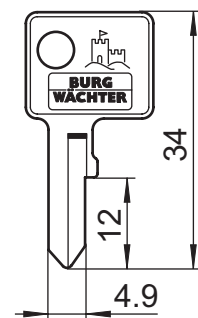
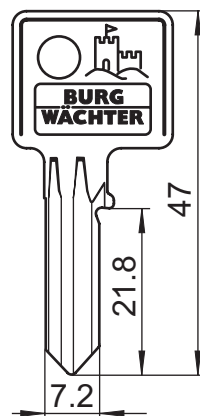
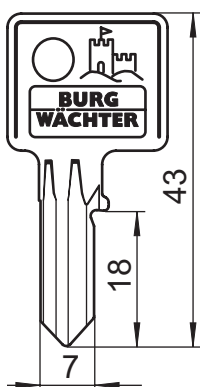
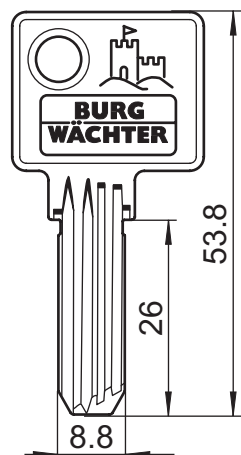

Rohling-Nr.

Item-no.
No de l'ébauche

76 W

67 R

68 R

45 L

EDV Nr.

14730

80

130

5220

Passend zu

Fits
Compatible avec

450/50 - 60

770/30
460 NI 30
444/50
400E/30
222/30 - 35
(ab 02/2016)

770/40 - 50 - 60
771 F 40 Berlin &
London SB
460 NI 40 + 50
444/70 - 90
400E/35 - 40
- 45 - 50 - 60

222/15 - 20 - 25

VE / Unit / Cdt

20

20

20

20

Schlüsselform

Flat keys & Shape

Forme de la clé

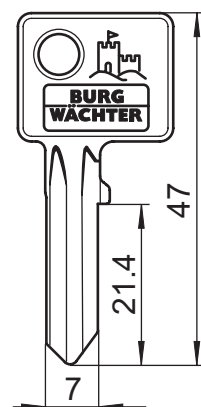
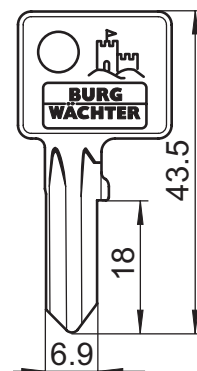
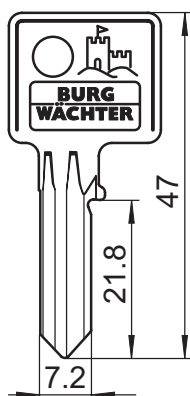
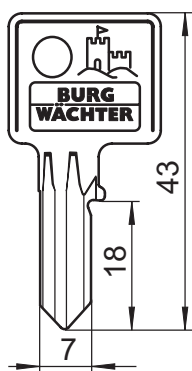

Rohling-Nr.

Item-no.
No de l'ébauche

38 R

39 R

77 R

78 R

EDV Nr.

190

4200

36300

36310

Passend zu

Fits
Compatible avec

222/30 - 35
(bis 02/2016)

222/40 - 45 - 50
- 60

402/30
21/60
405/30

402/40 - 50
21/70
405/40 - 50

VE / Unit / Cdt

20

20

20

20



Schlüsselform

Flat keys & Shape

Forme de la clé

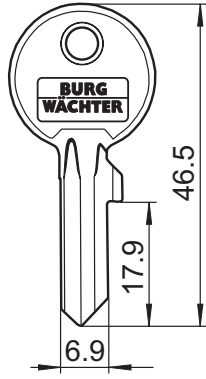

~

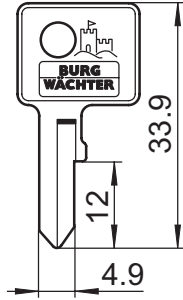

F

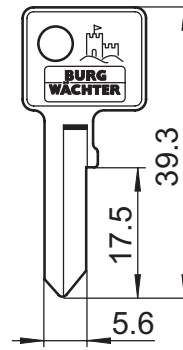

F

Zweiradschlüssel / Bicycle locks / deux-roues serrures



Schlüsselform

Flat keys & Shape

Forme de la clé

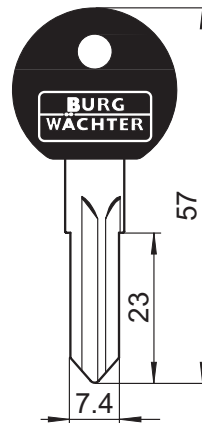
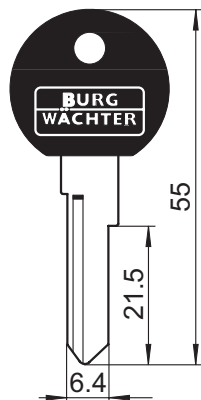
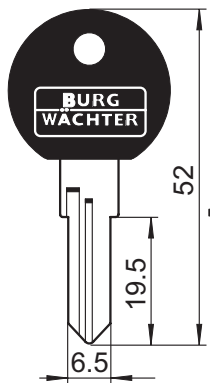

Rohling-Nr.

Item-no.
No de l'ébauche

72 W

71 R

73 W

EDV Nr.

5960

5880

5970

Passend zu

Fits
Compatible avec

240/50

550/80, 650/80
1550/150
1650/180
1500 HB 170/180
1500 HB 170/255

570/120

VE / Unit / Cdt

20

20

20

Schlüsselform

Flat keys & Shape

Forme de la clé

Rohling-Nr.

Item-no.
No de l'ébauche

EDV Nr.

Passend zu

Fits
Compatible avec

VE / Unit / Cdt

Universalzyl./Möbelschloss / All-round cam/Furniture locks // Serrures univers.



Schlüsselform

Flat keys & Shap

Forme de la clé

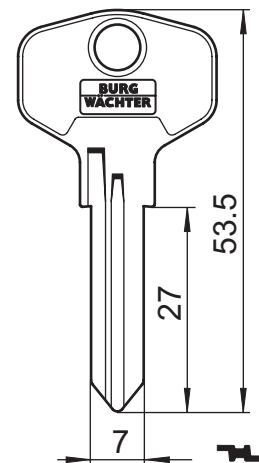
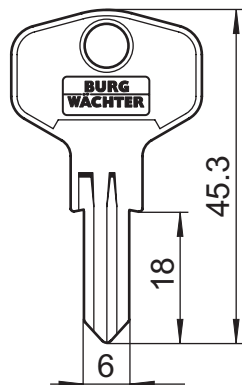
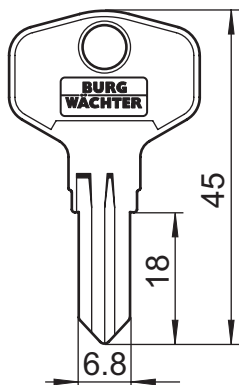
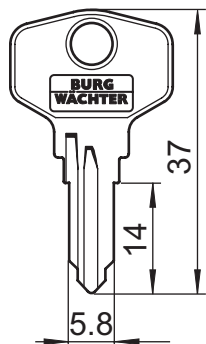

Rohling-Nr.

Item-no.

No de l'ébauche

33 W

34 W

35 W

36 W

EDV Nr.

2400

26960

26970

52060

Passend zu

Fits

Compatible avec

ZS 76
ZS 77
ZS 77 H
ZS 80
ZS 81
ZS 82

ZBK 71
ZBK 72
ZBK 73
ZBK 74
ZBK 75

ZBK 70

ZS 85
(alte Ausführung)
ZS 86
(alte Ausführung)

VE / Unit / Cdt

20

20

20

20

Schlüsselform

Flat keys & Shape

Forme de la clé

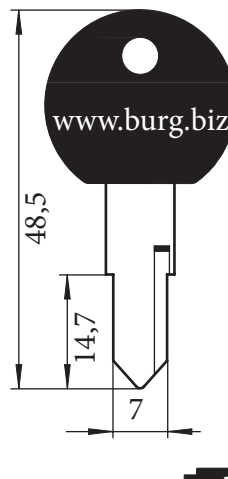
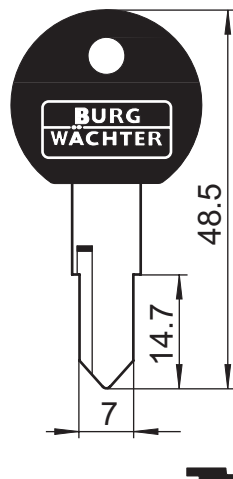
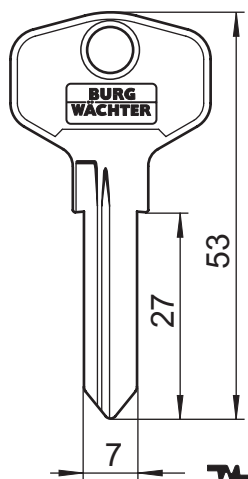

Rohling-Nr.

Item-no.

No de l'ébauche

36 W (V-Profil)

40 RW

40 LW

EDV Nr.

17560

1870

1660

Passend zu

Fits

Compatible avec

ZS 85 - ZS 86

BK 92 Point
Türkette
VTK 90 SB

BK 92 Point
Türkette
VTK 90 SB

VE / Unit / Cdt

20

20

20



**BURG
WÄCHTER**

Möbelschlösser / Furniture locks / Serrures pour meubles

Schlüsselform

Flat keys & Shap

Forme de la clé

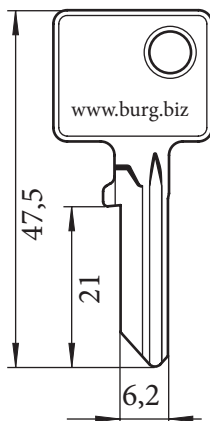
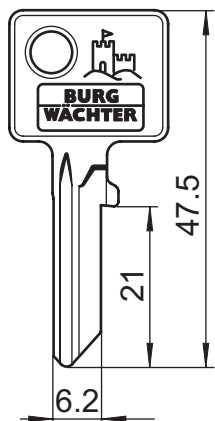

Rohling-Nr.
Item-no.
No de l'ébauche

65 R

65 L

10 R

EDV Nr.

6390

6380

4010

Passend zu
Fits
Compatible avec

MZ 23
MZ 23 20

MZ 23
MZ 23 20

MZ 83

VE / Unit / Cdt

50

50

20

Tür- und Fenstersich./ Door a. window security / sécurité p. portes et fenêtres

Schlüsselform

Flat keys & Shape

Forme de la clé

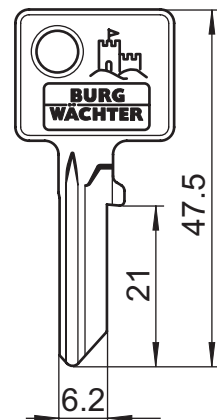
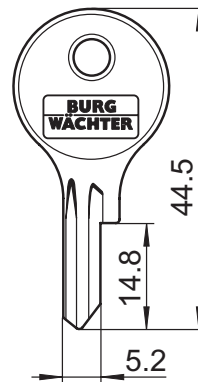
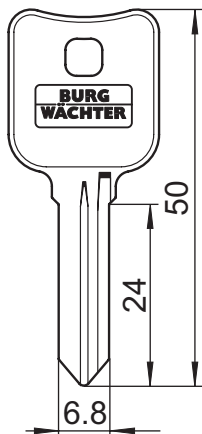

Rohling-Nr.
Item-no.
No de l'ébauche

79 W

12 R

12 B

65 R

EDV Nr.

38450

3970

3900

6390

Passend zu
Fits
Compatible avec

Fenstersicherung
WS 11
WS 22
WS 33
WZ 60

Fenstersicherung
W1
WD3

Fenstersicherung
RZ 60
RZ 90

B1
BS 2

VE / Unit / Cdt

20

20

20

50

Schlüssellochsperrerr / Lock-blocking keys / Dispositifs de sécurité, clés de blocage



Schlüsselform

Flat keys & Shape

Forme de la clé

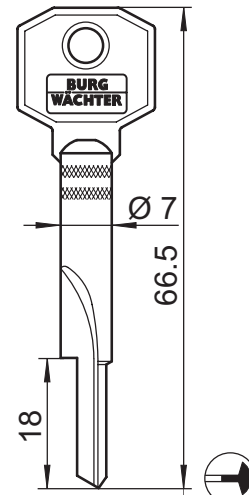
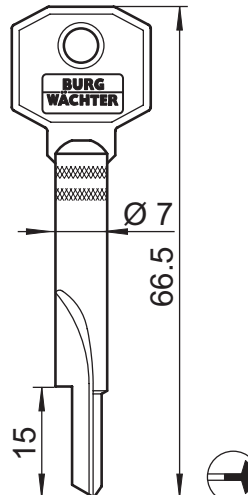
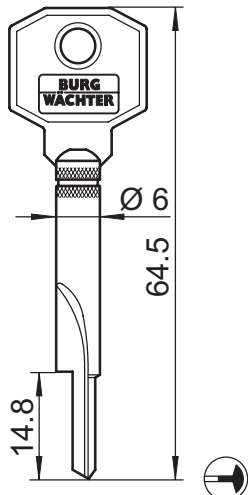
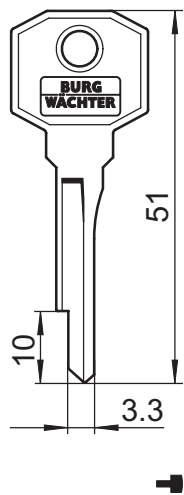

Rohling-Nr.

Item-no.

No de l'ébauche

14

22

24

26

EDV Nr.

4510

4550

4570

4590

Passend zu

Fits

Compatible avec

Möbelsperrerr
ME

Schlüssel-
lochsperrerr E 6

Schlüssel-
lochsperrerr E 7

Schlüssel-
lochsperrerr E 700

VE / Unit / Cdt

20

20

20

20

Einbausicherung

Integration

protection

Adaption protection

Schlüsselform

Flat keys & Shape

Forme de la clé

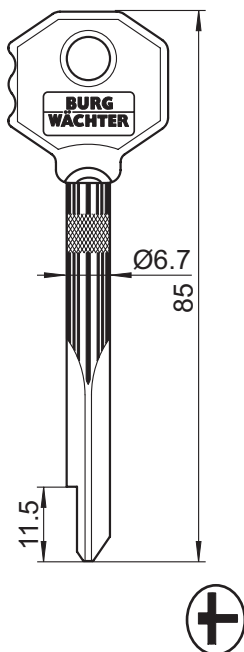

Rohling-Nr.

Item-no.

No de l'ébauche

29

EDV Nr.

4240

Passend zu

Fits

Compatible avec

Einbausicherung
ES 10
ESA 10

VE / Unit / Cdt

20



Schlüsselform

Flat keys & Shape

Forme de la clé

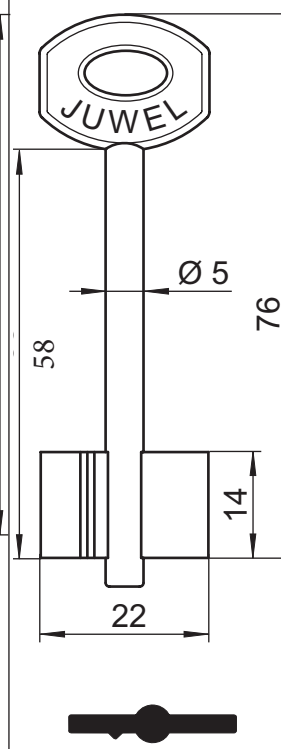
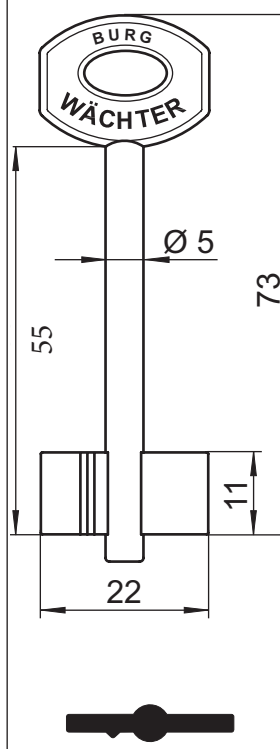
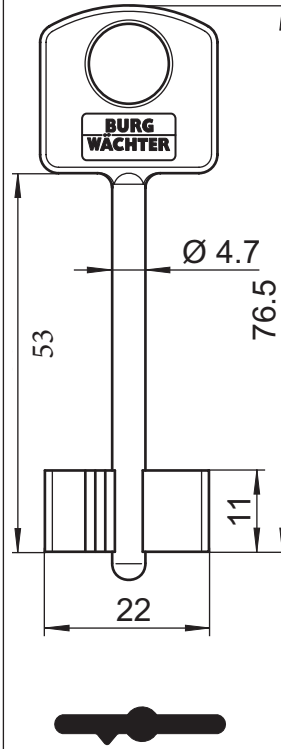
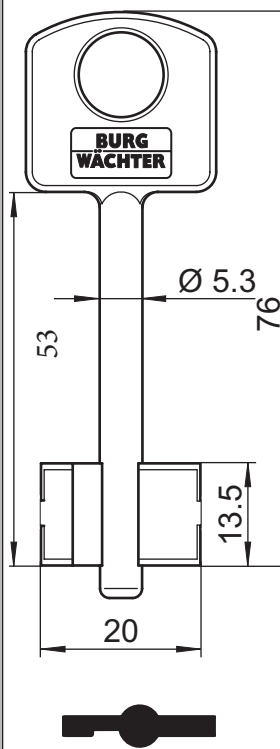

Rohling-Nr.
Item-no.
No de l'ébauche

17 B

17 C

18

18 B

EDV Nr.

16810

37080

16680

16690

Passend zu
Fits
Compatible avec

Möbeltresore
Point-Safes
(bis 12/2013)

Wandtresore
Point-Safes
(bis 12 2013)

Möbeltresore
Point-Safes
(ab 2014)

Wandtresore
Point-Safes
(ab 2014)

Möbeltresore
MT 22 + 23
(bis 03/87)
MT 33
(bis 06/87)
MT 34-36, 139
(bis 05/84)

Wandtresore
Junior WT 3

CityLine CW 1 - 4

Serie WT 4
(bis 03/87)
Serie 6
(bis 06/84)

Juwel WT 9
(bis 06/84)

Bodentresore
BT 13
(bis 06/88)

Möbeltresore & Geldschränke
MT 34 - 48
(05/84 - 06/87)

139/149
(05/84 - 06/87)

Wandtresore
Serie WT 5
(Modell 5/5 bis 5/7 350)

Serie WT 6
(01/84 - 08/88)

Juwel WT 9
(ab 06/84)

VE / Unit / Cdt

5

5

3

3



Tresore / Safes / Coffres-forts

Schlüsselform

Flat keys & Shape

Forme de la clé

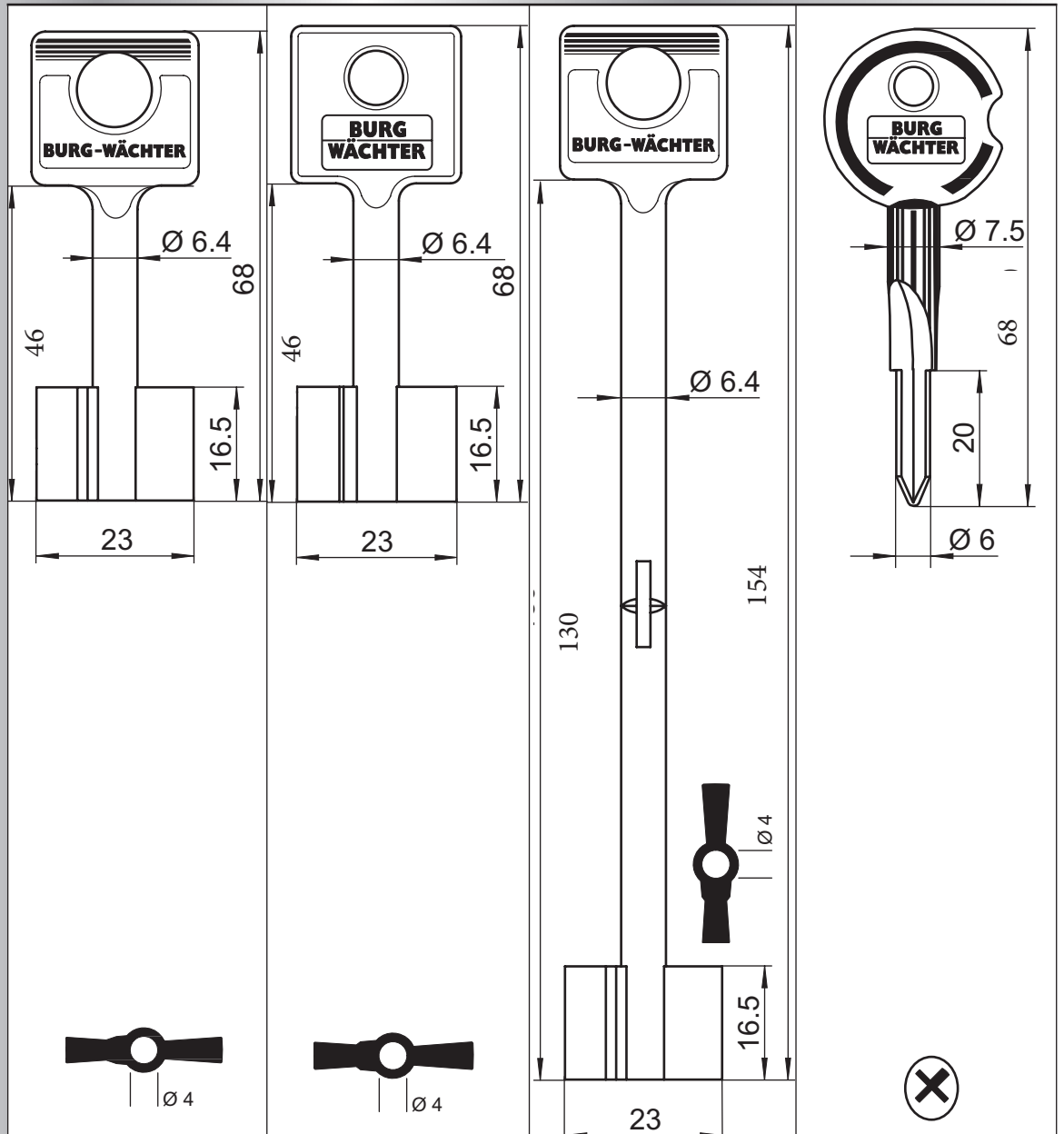

Rohling-Nr. Item-no. No de l'ébauche	50	51	52	53 X
EDV Nr.	16660	16670	16700	16890
Passend zu Fits Compatible avec	<p>Möbeltresore & Wertschutzschränke Diamant MT 33 (ab 07/87) Diplomat MT(D) 34-48 (ab 07/87 bis 3/2002) Diplomat MT(D) 139/149 (ab 07/87 bis 3/2002)</p> <p>Wandtresore Serie WT 6 (ab 08/88) Diplomat WT 10 Bodentresor BT 13 (ab 06/88) WT 10/4-10/8 (ab 6/94 bis 3/2002)</p>	<p>Möbeltresore MT 22, 23 (ab 3/87) MT 24 (N), 26 (N) (3/87 bis 3/2002) Diamant MT 31-32 HomeSafe H1, H3, H4 CityLine C1/C2 - C17/C18 Karat 300 Ranger A5, A7, W 7 A/B Waffenschränk WS 1, WS 2</p> <p>Wandtresore WT 4 Home (ab 03/87) Karat WT 11-16 Karat WT 14 N, 16 N (ab 11/2001 bis 3/2002) CityLine CW5-350 Innentresor IT 2 (für Royal+Karat 300)</p> <p>Innentresore Royal 500 Karat 300 RS 1/7 - Ranger W7 A/B</p>	<p>Panzer-Geldschränke</p> <p>Schlüssel für Serie ROYAL (Sicherheitsstufe B) nur als eingeschnittener Schlüssel gegen Mustervorlage.</p> <p>Mit oder ohne Gelenk lieferbar.</p>	<p>Tresore Notschlüssel bei Point-Safe Serie E Schubladensafe Box 1 E (bis 12/2013)</p>
VE / Unit / Cdt	3	3	3	10



Tresore / Safes / Coffres-forts

Schlüsselform

Flat keys & Shape

Forme de la clé

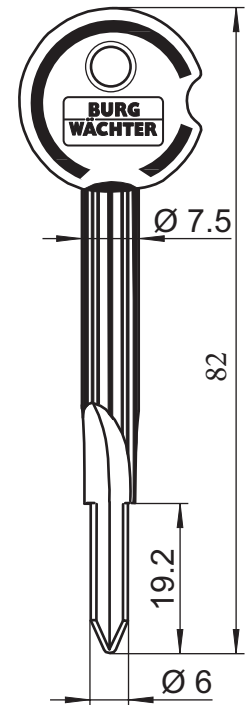
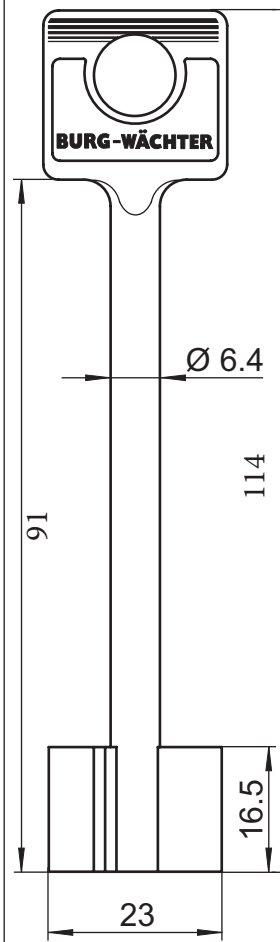
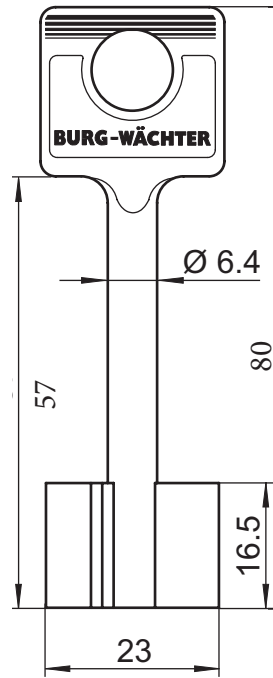
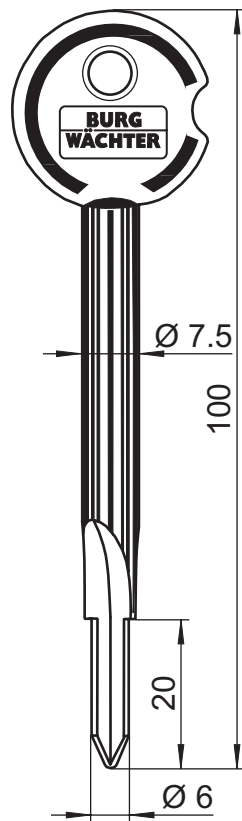

Rohling-Nr.
Item-no.
No de l'ébauche

54 X

55

60 OL

**Point
NOS 2014**

EDV Nr.

16080

33610

16880

37950

Passend zu
Fits
Compatible avec

Tresore
Notschlüssel bei
Feuerschutztresor
FP 2 E

Tresore
CL 10
CL 20
CL 40
(ab Serienstart
03/2008)

Tresore
für OL 101 bis 126
ab Serienstart 1998
bis 03/2002

Tresore
Notschlüssel bei
Point-Safe Serie E
(ab 2014)

VE / Unit / Cdt

10

3

3

10

Musterschlüssel Z-Schließungen

Profil 65 R, Serie 116/30

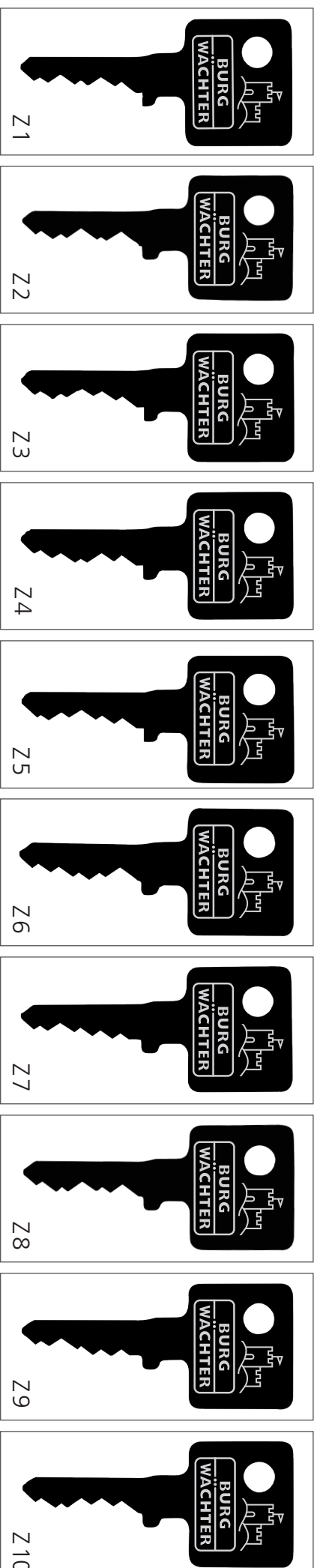

Musterschlüssel Z-Schließungen

Profil 66 R, Serie 116/40, 50, 60

