

Messschieber mit Feststellschraube DIN 862 „TOP“

Vernier caliper with set screw DIN 862, „top“

- aus rostfreiem Stahl
- mattverchromt, ganz gehärtet
- für 4-fach Messung geeignet
- Rückseite mit Gewindetabelle
- DIN 862
- im Etui

- made of stainless steel
- satin chrome finished, hardened
- 4-way measurements
- backside with screw table
- DIN 862
- in case

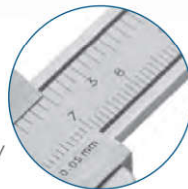

erhöhte Gleitschienen / with higher sliderails

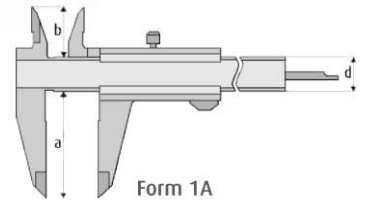
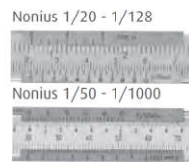

Bestell-Nr. Order-No.	Messbereich Range mm	Nonius mm unten - below	Nonius inch oben - above	a mm	b mm	d mm	kg	Euro/St. Euro/Pc.
01001006	150	1/20 - 39	1/128"	40	17	16	0,17	32,00
01001008	150	1/50 - 49	1/1000"	40	17	16	0,17	33,00
01001009	200	1/20 - 39	1/128"	50	17	16	0,19	47,00
01001010	300	1/20 - 39	1/128"	60	25	17	0,38	79,00

Messschieber mit Momentverstellung DIN 862 „TOP“

Vernier caliper with auto lock DIN 862, „top“

- aus rostfreiem Stahl
- mattverchromt, ganz gehärtet
- für 4-fach Messung geeignet
- Rückseite mit Gewindetabelle
- DIN 862
- im Etui

- made of stainless steel
- satin chrome finished, hardened
- 4-way measurements
- backside with screw table
- DIN 862
- in case

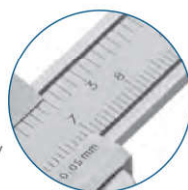
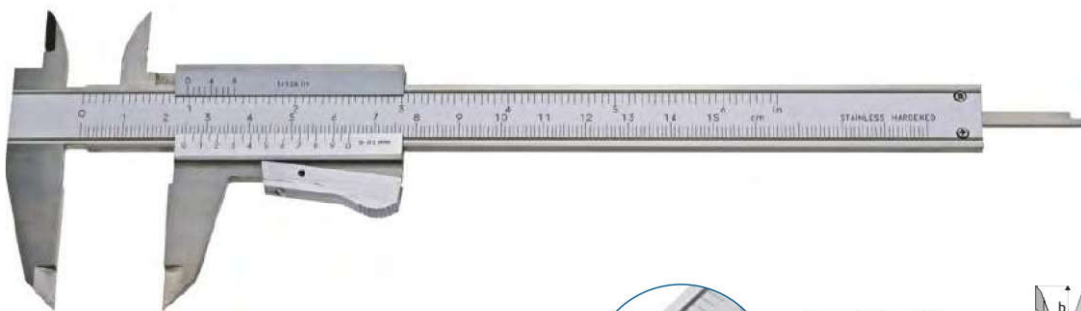

erhöhte Gleitschienen / with higher sliderails

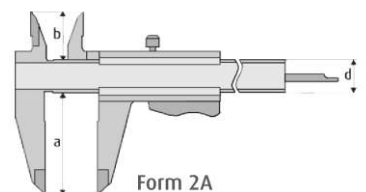
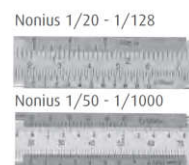

Bestell-Nr. Order-No.	Messbereich Range mm	Nonius mm unten - below	Nonius inch oben - above	a mm	b mm	d mm	kg	Euro/St. Euro/Pc.
01001005	150	1/20 - 39	1/128"	40	17	16	0,17	33,00
01001007	150	1/50 - 49	1/1000"	40	17	16	0,17	34,00
01001011	200	1/20 - 39	1/128"	50	17	16	0,19	48,50
01001012	300	1/20 - 39	1/128"	60	25	17	0,38	86,00