



**POWER TO KEEP  
YOU ON THE MOVE**

**Electric  
Vehicle  
Gel**

**ELECTRIC VEHICLE** applications are wide and varied with many durability & power demands placed firmly on the batteries shoulders.

**ELECTRIC VEHICLE GEL** always delivers when you need it, whatever your DC requirement in extreme situations.



**Tough ABS case with INSERT TERMINALS as standard, smaller sizes with FASTON.**

**Special Active Material Formulation & Gel Technology delivers cranking amps, general power and long/deep discharges without the need for immediate recharge.**

**EXTRA LONG CYCLE LIFE and resistance to mechanical stress and the elements all in one battery.**

Dimensions mm - kg						Dimensions Inches - lbs						Cold Cranking Amps		
Length	Width	Height Auto	Height Insert	Height Battery	Weight	Length	Width	Height Auto	Height Insert	Height Battery	Weight	20°C (68°F)	0°C (32°F)	-18°C (0°F)
530	209	234	217	214	54.9	20.87	8.23	9.21	8.54	8.43	121.1	1028	938	811

Volts	Thread size mm	Reserve Capacity - Mins					Capacity - Ampere Hour*							
		75 Amps	<b>25 Amps</b>	20 Amps	15 Amps	8 Amps	100 Hr	48 Hr	<b>20 Hr</b>	10 Hr	5 Hr	3 Hr	1 Hr	
12	8	94.7	318	414	582	1200	220	206	191	175	158	141	108.0	

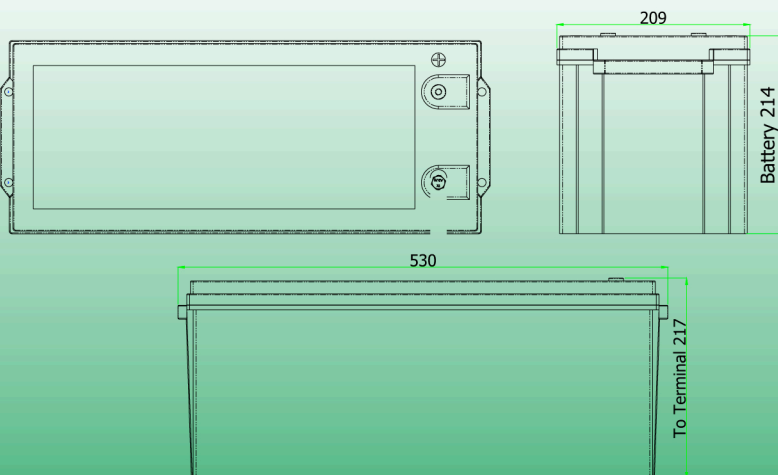

**EV Charging** - To obtain maximum cycle life from your EV battery it is important that a suitable charging profile is used.

**NOTE:** Gel batteries are true Gel batteries, plate chemistry is specifically for cyclic applications, the microporous polymer gel separator and the gelling agents are European made and imported specially for Gel production.

**ELECTRIC VEHICLE GEL delivers maximum capacity within twenty cycles and keeps delivering long after the others are on the scrap heap. R&D has resulted in SPECIAL CHEMICAL and PROCESS technology to ensure consistency and performance.**

# Charging Characteristics - Constant voltage charging

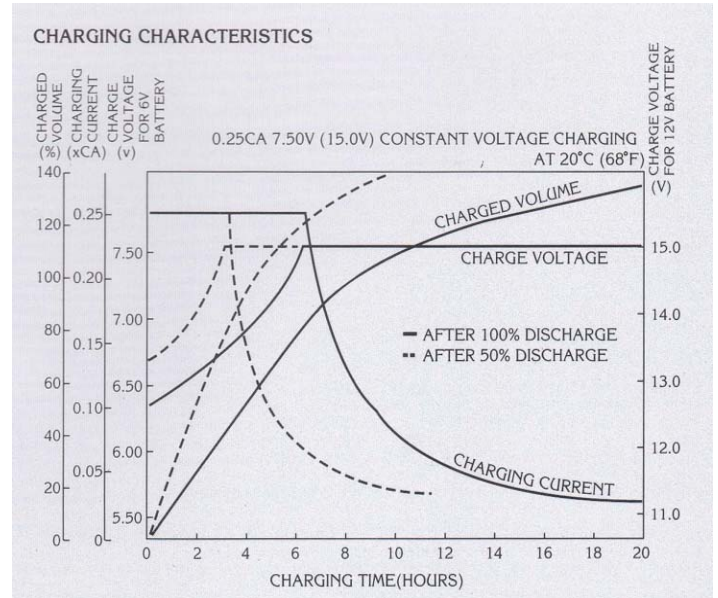
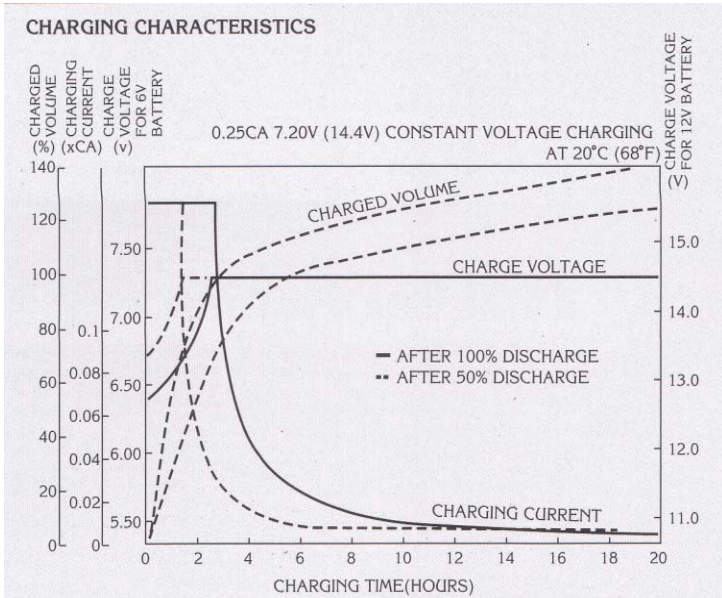
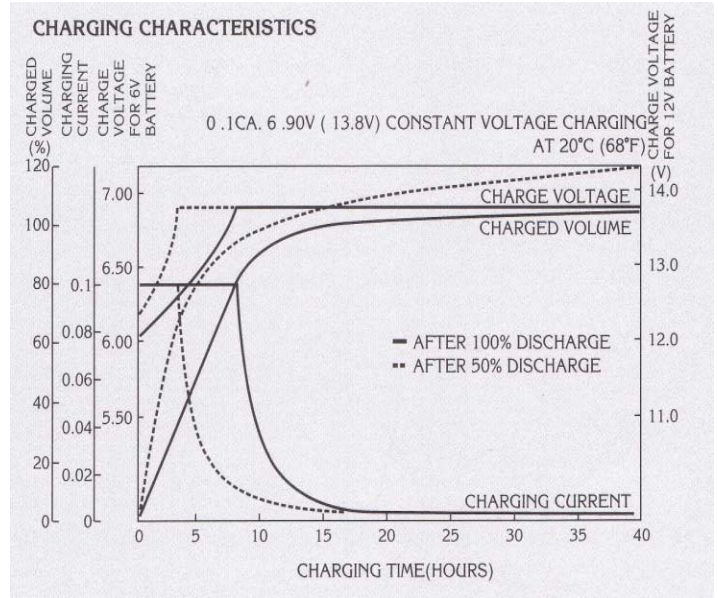
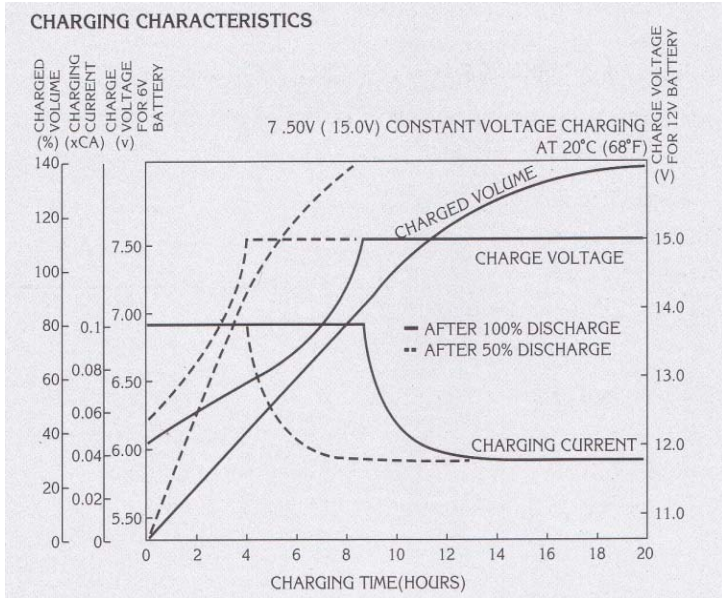
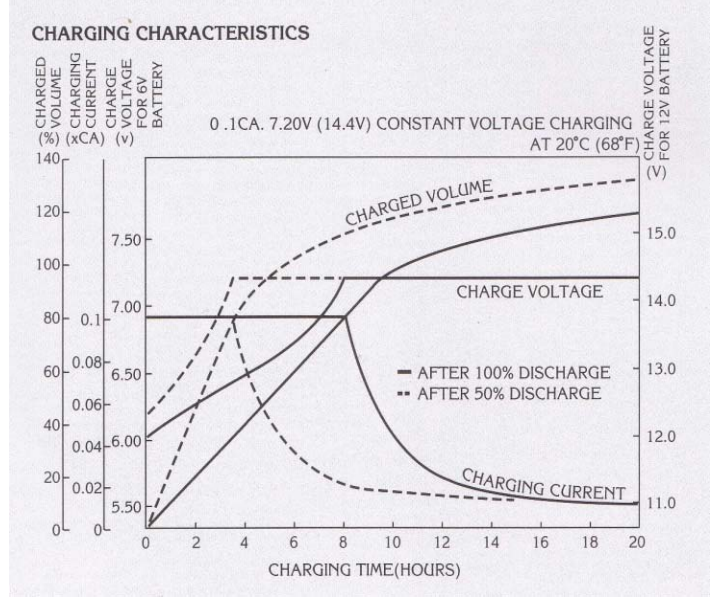
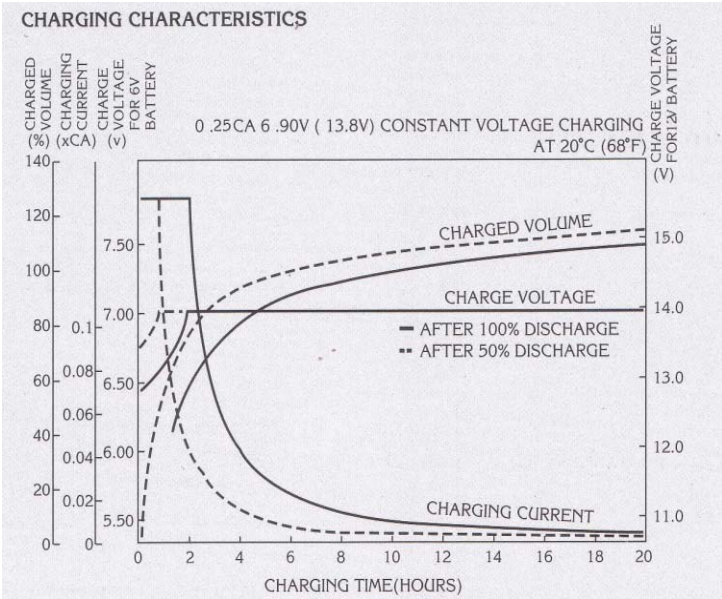

Applicable to AGM and Gel products

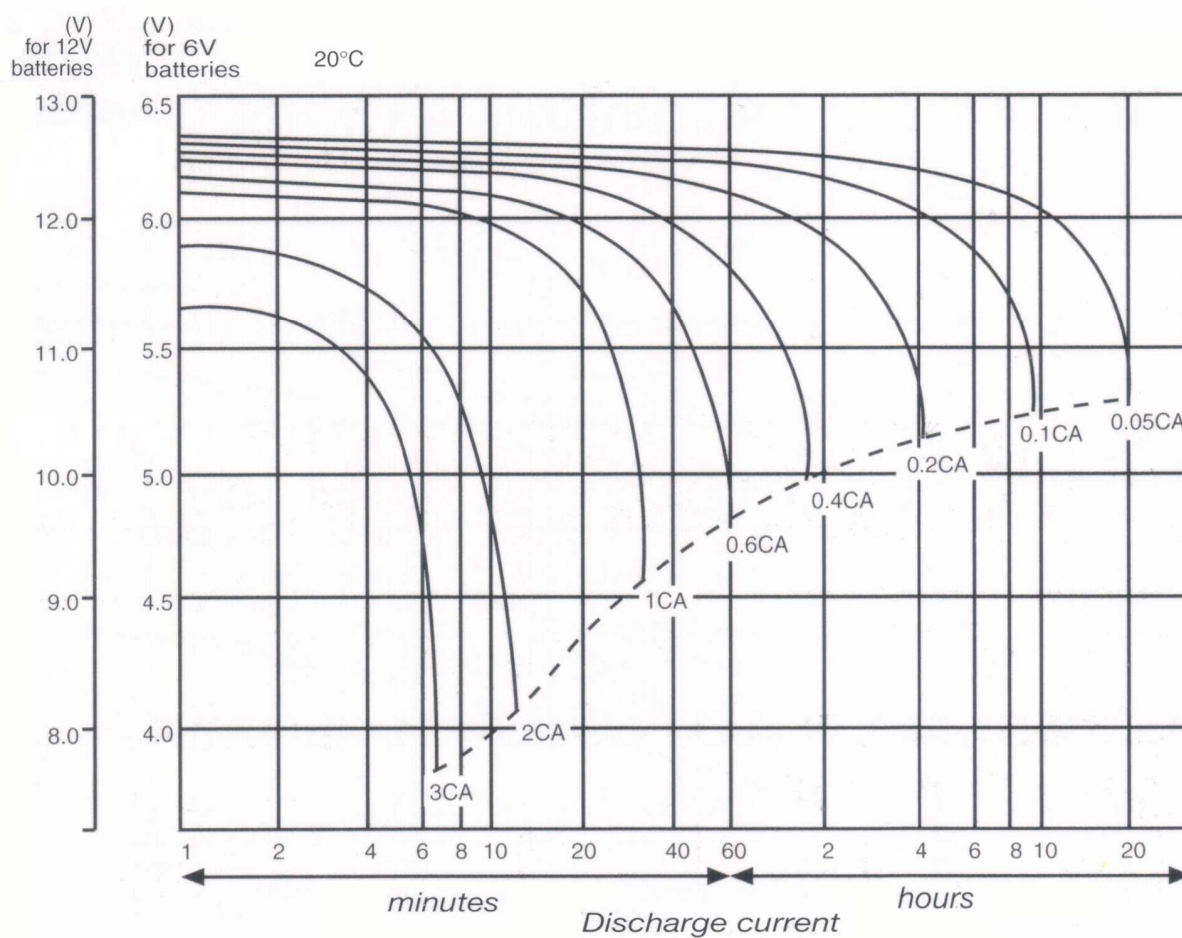

Note: Battery specific discharge curves are not published, as there is very little variation in the lead/acid discharge profile due to battery size of plate profile.