

ELECTRIC VEHICLE applications are wide and varied with many durability & power demands placed firmly on the batteries shoulders.

ELECTRIC VEHICLE AGM always delivers when you need it, whatever your DC requirement in general EV applications.



Tough ABS case with INSERT TERMINALS as standard, smaller sizes with FASTON.

Special Active Material Formulation & AGM Technology delivers cranking amps, general power and long/deep discharges.

GOOD CYCLE LIFE and resistance to mechanical stress and the elements all in one battery.

Dimensions mm - kg						Dimensions Inches - lbs						Cold Cranking Amps		
Length	Width	Height Auto	Height Insert	Height Battery	Weight	Length	Width	Height Auto	Height Insert	Height Battery	Weight	20°C (68°F)	0°C (32°F)	-18°C (0°F)
522	242	240	225	220	63.7	20.55	9.53	9.45	8.86	8.66	140.5	1145	1037	954

Volts	Thread size mm	Reserve Capacity - Mins					Capacity - Ampere Hour*							
		75 Amps	25 Amps	20 Amps	15 Amps	8 Amps	100 Hr	48 Hr	20 Hr	10 Hr	5 Hr	3 Hr	1 Hr	
12	8	146	449	578	816	1695	260	244	226	203	182	168	134	

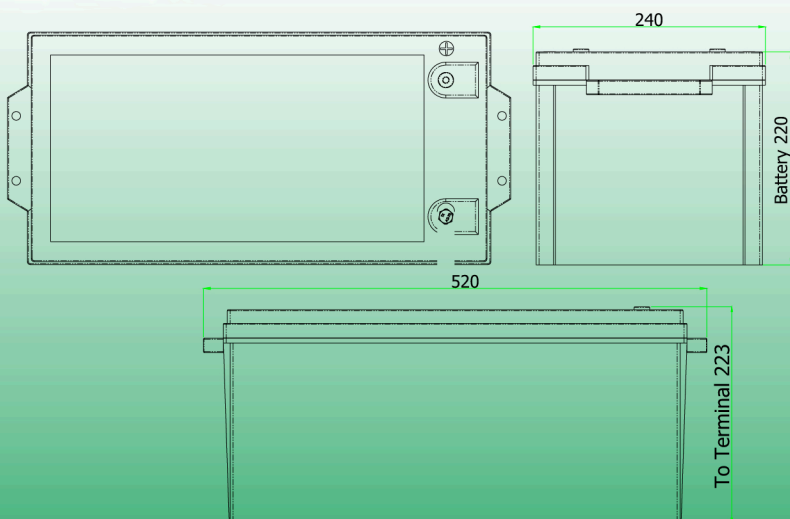

EV Charging - To obtain maximum cycle life from your EV battery it is important that a suitable charging profile is used.

NOTE: AGM batteries are true cycling batteries, plate chemistry is specifically for cyclic applications.

ELECTRIC VEHICLE AGM delivers maximum capacity within five cycles and keeps delivering long after the others are on the scrap heap. R&D has resulted in SPECIAL CHEMICAL and PROCESS technology to ensure consistency and performance.

Charging Characteristics - Constant voltage charging

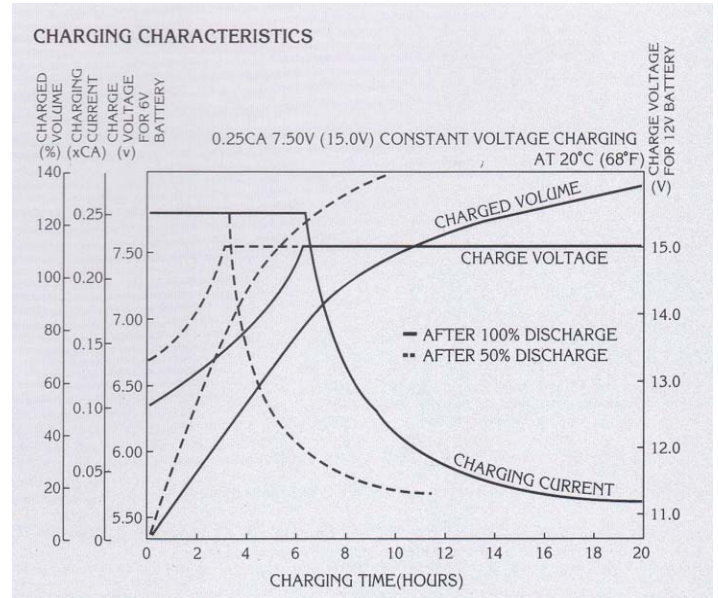
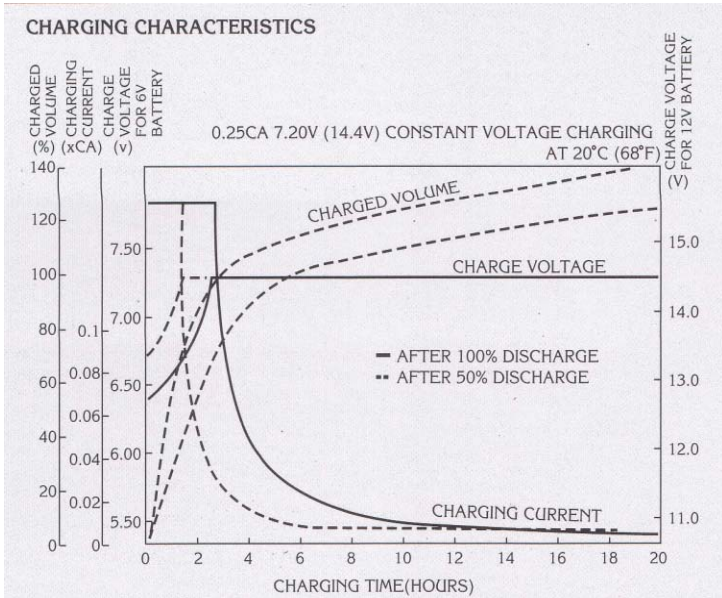
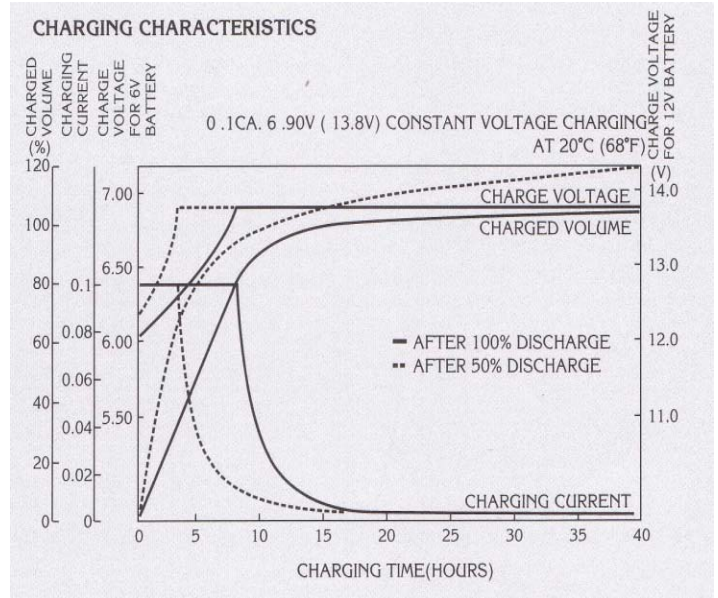
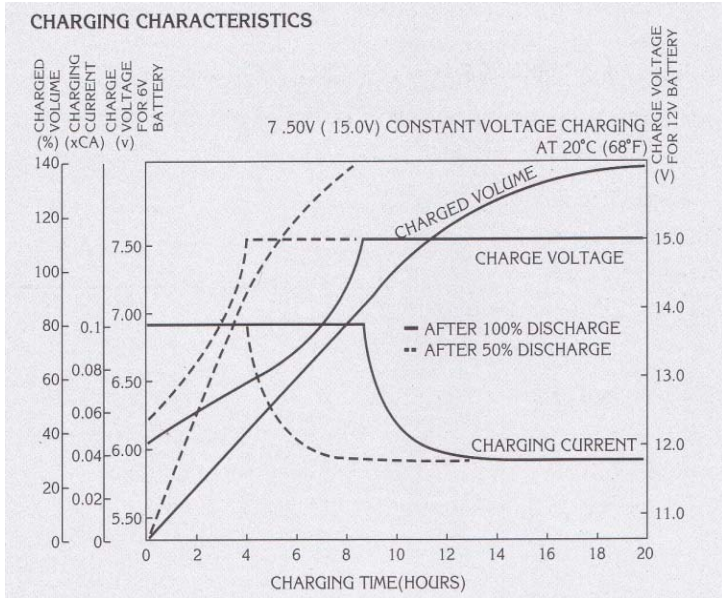
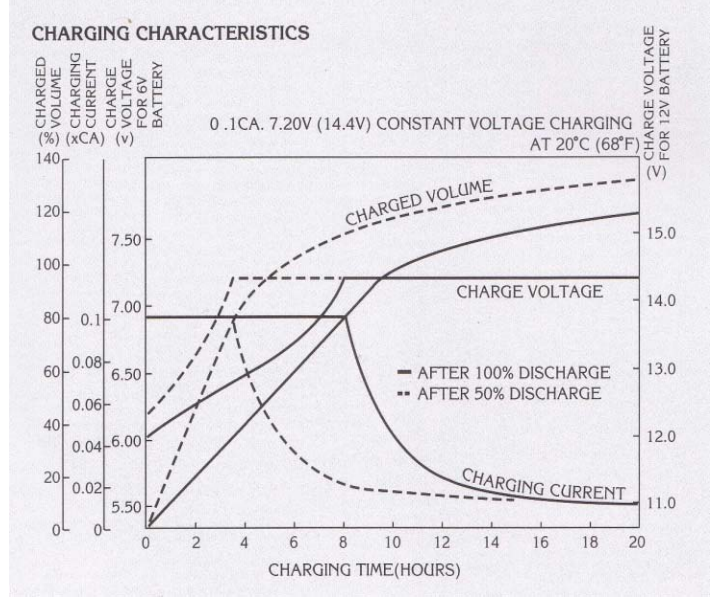
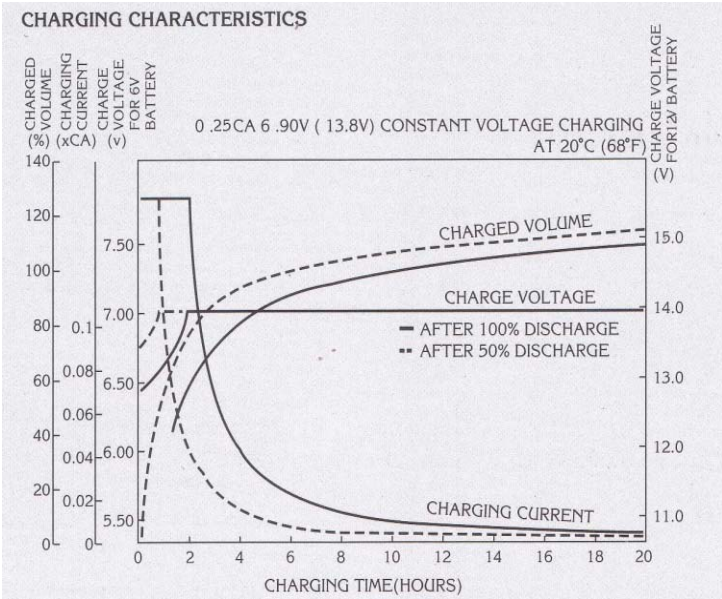

Applicable to AGM and Gel products

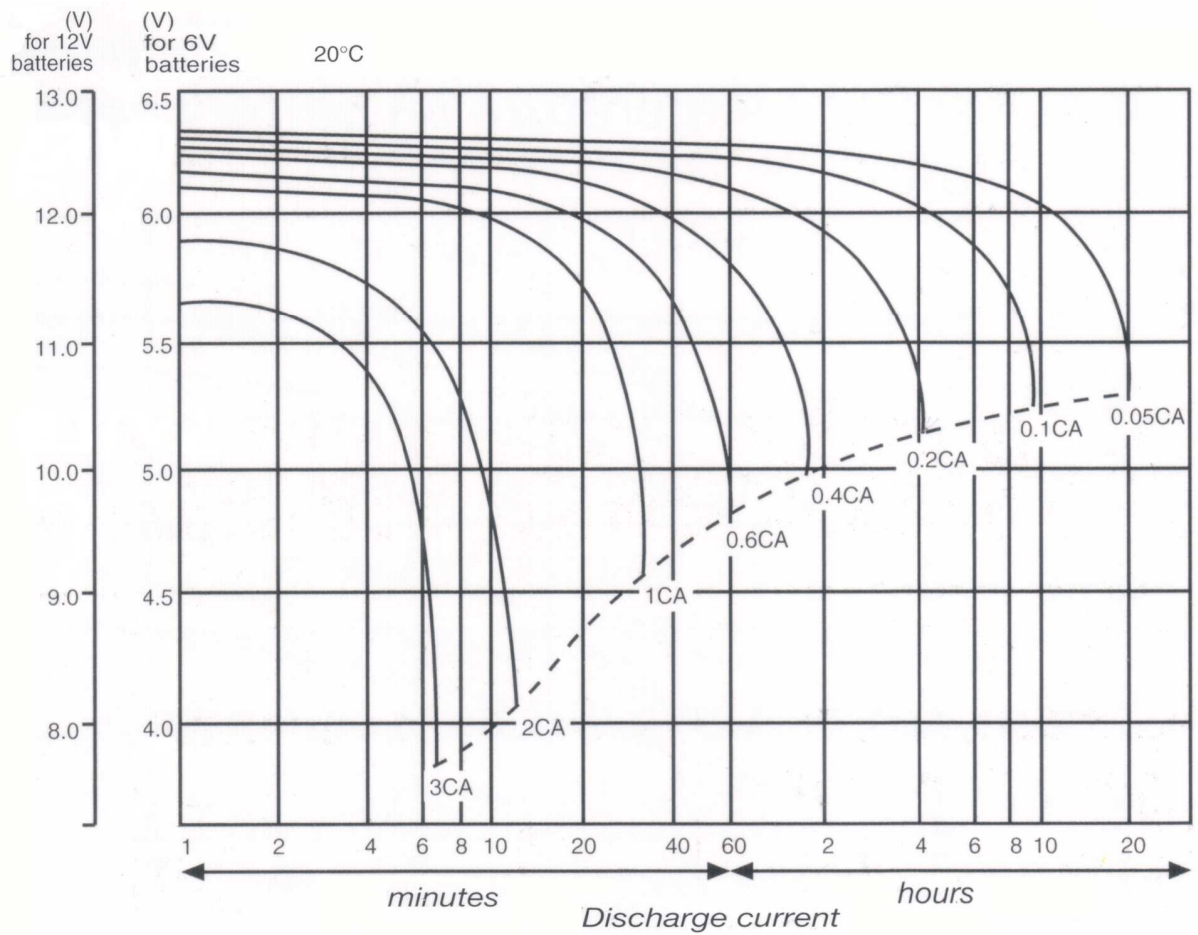

Note: Battery specific discharge curves are not published, as there is very little variation in the lead/acid discharge profile due to battery size of plate profile.